

DTSU666 series three phase four wire electronic energy meter (Din-rail)

DSSU666 series three phase three wire electronic energy meter (Din-rail)

Manual

ZTY0.464.1002

Zhejiang Chint Instrument & Meter Co., Ltd.

Jan., 2018.

DTSU666 series and DSSU666 series three phase electronic energy meter(DIN-Rail)	ZTY0.464.1002
Operation manual	Page 2, Total 13

with small volume, easy installation and easy networking

1.3 Model composition and meanings

Table 1 product model and specification

Model	Reference voltage (V)	Current specification (A)	Pulse constant		Accuracy class
			imp/kWh	imp/kvarh	
DTSU666	3×230/400	1.5(6)A	6400	6400	0.5
		5(80)A	400	400	1
DSSU666	3×400	1.5(6)A	6400	6400	0.5
		5(80)A	400	400	1

1.4. Environmental conditions

1.4.1. Temperature range

Indoor type:

Regulated working temperature range: $-10^{\circ}\text{C} \sim +45^{\circ}\text{C}$;

Limited working temperature range: $-25^{\circ}\text{C} \sim +75^{\circ}\text{C}$;

1.4.2 Relative humidity(Annually average): $\leq 75\%$;

1.4.3 Atmospheric pressure: 63.0kPa \sim 106.0kPa(altitude 4km and below), excepting the requirements for special orders.

2. Main Technical Performance & Parameters

2.1 Start and Defluction

2.1.1. Start

Under the power factor of 1.0 and started current, the instrument can be started and continuously measure (for multiple phase instrument, it will bring balanced load). If the instrument is designed based on measurement for dual directional energy, then it is applicable for each direction of energy.

Table 3 start current

instrument	Instrument rating			Power factor
	0.5S	1	2	
Direct access instrument	-	$0.004I_b$	$0.005I_b$	1

DTSU666 series and DSSU666 series three phase electronic energy meter(DIN-Rail)	ZTY0.464.1002
Operation manual	Page 3, Total 13

Access via CT	0.001I _b	0.002I _b	0.003I _b	1
---------------	---------------------	---------------------	---------------------	---

2.1.2. Defluction

When adding voltage while there is no current on the current circuit, the test output of the instrument shall not produce another pulse. When testing, the current circuit shall be opened, and the added voltage for voltage circuit shall be 115% of the referenced voltage.

Shortest testing time Δt :

For instrument of class 0.5S and class1:
$$\Delta t \geq \frac{600 \times 10^6}{k \cdot m \cdot U_n \cdot I_{\max}} [\text{min}]$$

For instrument of class 2:
$$\Delta t \geq \frac{480 \times 10^6}{k \cdot m \cdot U_n \cdot I_{\max}} [\text{min}]$$

From the formula, k represents meter constant (imp/kWh), m represents measuring components, U_n represents referenced voltage (V) and I_{max} represents the maximized current (A).

2.2. Electrical parameters

Table 3 Electrical parameters

Specified operating voltage range	0.9U _n ~1.1U _n	
Extended operating voltage range	0.8U _n ~1.15U _n	
Ultimate operating voltage range	0 U _n ~1.15U _n	
Power consumption of the voltage circuit	≤1.5W and 6VA	
Power consumption of the current circuit	I _b <10A	≤0.2VA
	I _b ≥10A	≤0.4VA
Data save time after power off	≥10 years	

3.Main function

3.1. Displayed function

From the displayed interface, the electrical parameter and energy data are all primary side data (that is, the multiplied by current and voltage ratios). The energy measuring value will be displayed

DTSU666 series and DSSU666 series three phase electronic energy meter(DIN-Rail)	ZTY0.464.1002
Operation manual	Page 4, Total 13

seven bits, with the displaying range from 0.00kWh to 9999999MWh.











Diagram 1 Liquid crystal display

Table 4 Display interface

No.	Display interface	Instruction	No.	Display interface	Instruction
1		Positive active energy =10000.00kWh	10		Phase C current =5.002A
2		Reserve active energy =2345.67kWh	11		Combined phase active power =3.291kW
3		Communication protocol is ModBus-RTU. N1 indicates that there are 1 stop bits without parity. 9.600 indicates that the baud rate is 9600bps 001 indicating table address	12		Phase A active power =1.090kW
4			13		Phase B active power =1.101kW
5		Phase A voltage =220.0V	14		Phase C active power =1.100kW

DTSU666 series and DSSU666 series three phase electronic energy meter(DIN-Rail)	ZTY0.464.1002
Operation manual	Page 5, Total 13

6		Phase B voltage =220.1V	15		Combined phase power factor PFt=0.500L
7		Phase C voltage =220.20V	16		Phase A power factor PFa=1.000L
8		Phase A current =5.000A	17		Phase B power factor PFb=0.500L
9		Phase B current =5.001A	18		Phase C power factor PFc=-0.500L

3.2.Programming function

3.2.1.Programming parameter

Table 5 Programming parameter

Parameter	Value range	Instruction
C_t	1~9999	Current ratio, used for setting the input loop current ratio: When the current is connected to the line via the transformer, C_t =the rated current of the primary loop / the rated current of the secondary circuit; When the current is directly connected to the line, C_t shall be set as 1.
P_t	0.1~999.9	Voltage ratio, used for setting the voltage ratio of the input loop; When the voltage is connected to the line via the

DTSU666 series and DSSU666 series three phase electronic energy meter(DIN-Rail)	ZTY0.464.1002
Operation manual	Page 6, Total 13

		transformer, Pt= the rated voltage of the primary loop / the rated voltage of the secondary circuit; When the voltage is directly connected to the line, Pt shall be set as 1.0.
<i>Prot</i>	1: 645	Communication protocol switches: 1: DI/T 645-2007;
<i>bAud</i>	0: 1.200; 1: 2.400; 2: 4.800; 3: 9.600;	Communication baud rate: 0: Communication baud rate to be 1200bps; 1: Communication baud rate to be 2400bps; 2: Communication baud rate is 4800bps; 3: Communication baud rate is 9600bps;
<i>Addr</i>	1~247	Communication address
<i>nEt</i>	0: n.34; 1: n.33;	Option for wiring mode: 0: n.34 represents three phase four wire; 1: n.33 represents three phase three wire.
<i>CLrE</i>	0:n0; 1:E	The setting is 1, representing the allowed instrument energy data clearance, which will be zero reset after clearing.
<i>PLuS</i>	0:P; 1:Q; 2:S;	Pulse output: 0: active energy pulse; 1: reactive energy pulse; 2: Others.
<i>dISP</i>	0~30	Display in turns(second) 0: Timely display; 1~30: Time interval of actual display.
<i>bLLd</i>	0~30	Backlight lighting time control (minutes) 0: Normally light; 1~30: backlight lighting time without button operation

3.2.2. Programming operation

Button description: “SET” button represents “confirmation”, or “cursor shift” (when input digits), “ESC” button represents “exit”, “→” (“”) button represents “add”. The input code is (default

DTSU666 series and DSSU666 series three phase electronic energy meter(DIN-Rail)	ZTY0.464.1002
Operation manual	Page 7, Total 13

701).

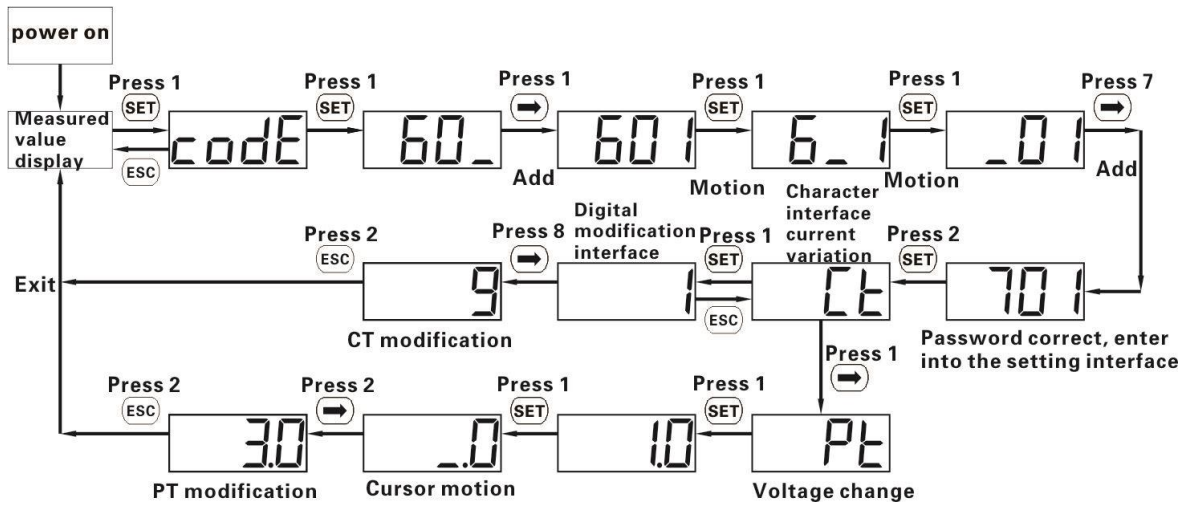

Diagram 2 Setting examples for current ratio

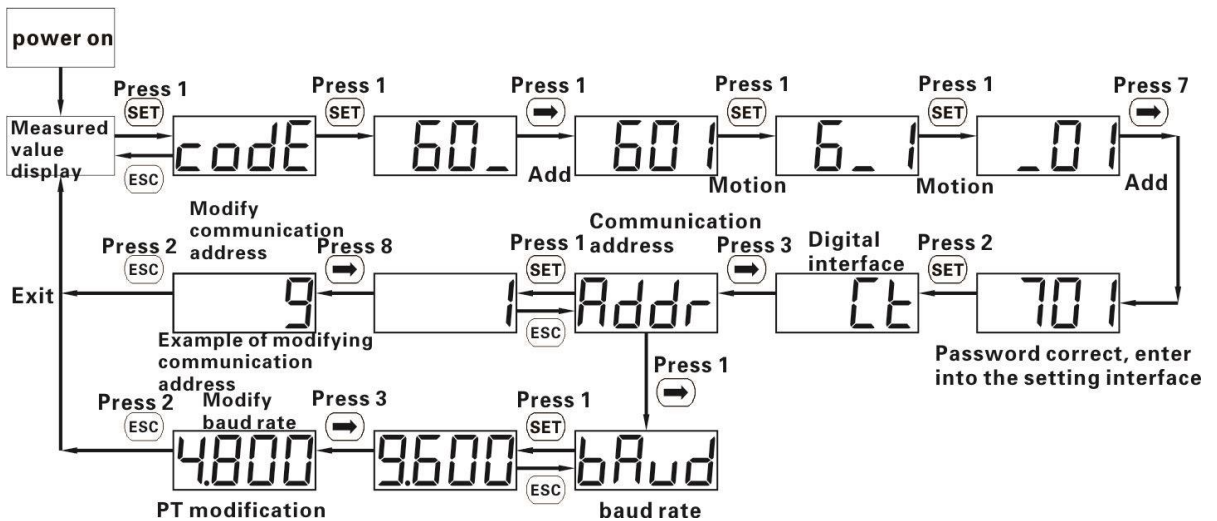

Diagram 3 Setting examples for communication address and baud rate

DTSU666 series and DSSU666 series three phase electronic energy meter(DIN-Rail)	ZTY0.464.1002
Operation manual	Page 9, Total 13

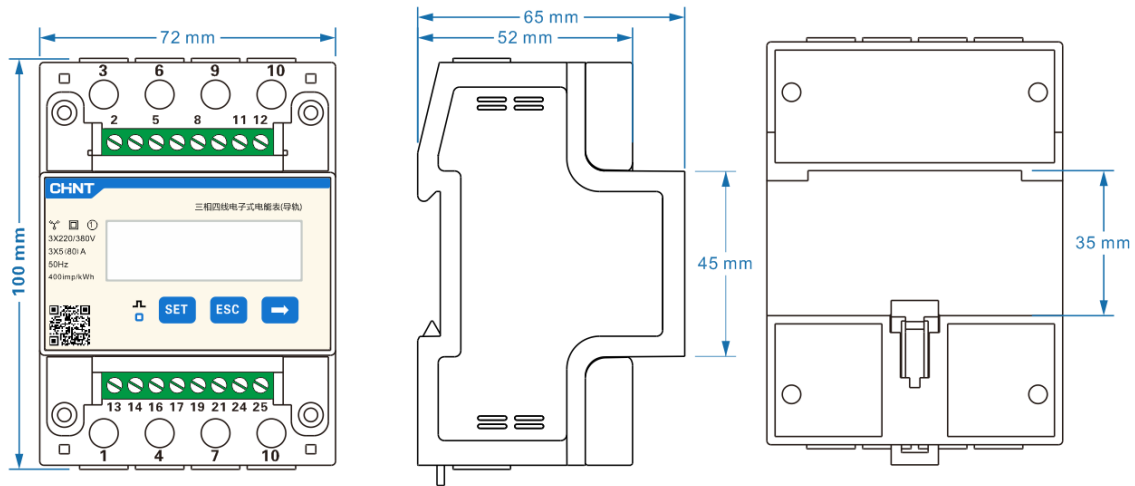

Diagram 5 Outline size diagram (four modulus)

5. Installation and operation manual

5.1. Inspection Tips

When unpacking the carton, if the shell has obvious signs caused by severe impact or falling, please contact with the supplier as soon as possible.

After the instrument being removed from the packing box, it should be placed on a flat and safe plane, facing up, not overlaying for more than five layers. If not installed or used in a short time, the electric meter shall be packed and placed to the original packing box for storage.

5.2. Installation and tips

5.2.1. Installation and Inspection

If the model No or configuration in the original packing box is not in accordance with the requirement, please contact with the supplier. While, if the inner package or shell has been damaged after removing the instrument from the packing box, please do not install, power on the instrument, please contact with the supplier as soon as possible, instead.

5.2.2. Installation

It requires experienced electrician or professional personnel to install it and you must read this operation manual. During the installation, if the shell has obvious damage or marks caused by violent impact or falling, please do not install it or power on and contact with the supplier as soon as possible.

DTSU666 series and DSSU666 series three phase electronic energy meter(DIN-Rail)	ZTY0.464.1002
Operation manual	Page 10, Total 13

5.3. Typical wiring

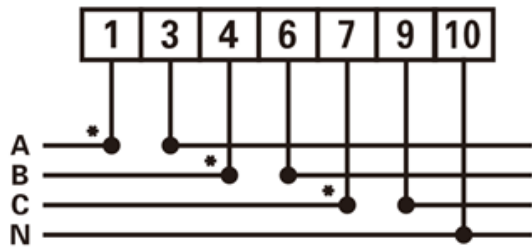

Three phase four wire: direct connect

Diagram 6

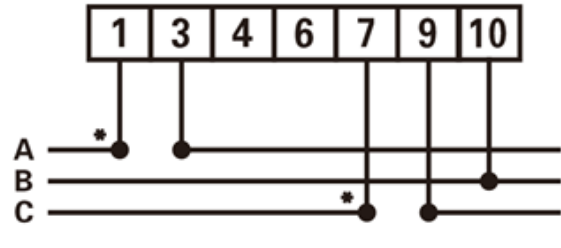

Three phase three wire: direct connect

Diagram 7

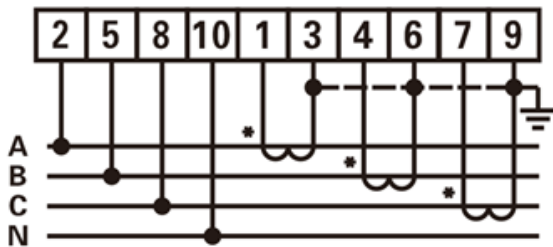

Three phase four wire: via current transformer

Diagram 8

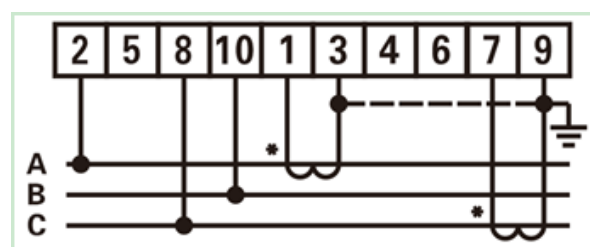

Three phase three wire: via current transformer

Diagram 9

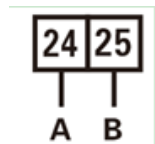

RS485

Diagram 10

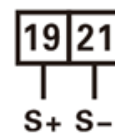

Pulse output

Diagram 11

◆ Voltage signal (only for connection via current transformer)

2-----UA (Phase A voltage input terminal)

8-----UC (Phase C voltage input terminal)

5 -----UB (Phase B voltage input terminal)

11-----UN (Phase N voltage input terminal)

◆ Current signal:

1-----IA*(Phase A current input terminal)

4-----IB*(Phase B current input terminal)

7-----IC*(Phase C current input terminal)

3-----IA (Phase A current output terminal)

6-----IB (Phase B current output terminal)

9-----IC(Phase C current output terminal)

◆ RS485 Communication wire

24-----A (RS485 Terminal A)

25-----B (RS485 Terminal B)

DTSU666 series and DSSU666 series three phase electronic energy meter(DIN-Rail)	ZTY0.464.1002
Operation manual	Page 11, Total 13

◆ Auxiliary function

19----- Active energy and reactive energy output high terminal

21----- Active energy and reactive energy output low terminal

6. Diagnosis, analysis and elimination for common faults

Fault phenomenon	Reason analysis	Elimination
Big deviation between electric energy measurement and actual value.	<ol style="list-style-type: none"> 1. Wiring error, voltage and current corresponding phase sequence is correct? 2. If the ends of the incoming and downstream ends of the current transformers reversed? Remarks: Please observe the power of Pa, Pb and Pc. If negative value occurs, it indicates abnormal. (except some special equipment) 	<ol style="list-style-type: none"> 1. If it is wrongly connected, please reconnect based on the right wiring mode (see the wiring diagram). 2. If not the above problems, please contact with the local supplier.
Abnormal data for the electrical parameter (voltage, current, power, etc.)	<ol style="list-style-type: none"> 1. The transformer's ratio hasn't been set, and the instrument displays the secondary side data. 2. Wrong wiring. 	<ol style="list-style-type: none"> 1. If setting the transformer ratio, please set the voltage ratio and current ratio based on "parameter setting" 2. If wrongly connected, please connect the voltage and current of phase A, B and C to the wiring terminal of the instrument.

7. Transportation & Storage

When transporting and unpacking the products, please confirm they are not severely impacted, transporting and storing based on *Transportation, basic environmental conditions and testing methods for instrument and meters* of JB/T9329-1999.

DTSU666 series and DSSU666 series three phase electronic energy meter(DIN-Rail)	ZTY0.464.1002
Operation manual	Page 12, Total 13

The instrument and accessories shall be stored in the dry and ventilated places, to avoid humidity and corrosive gas erosion, with the limited environmental temperature for storage to be 0°C ~+40°C and relative humidity not exceeding 85%.

8. Maintenance & Service

We guarantee free reparation and change for the multi-meter if found any unconformity with the standard, under circumstance of that the users fully comply with this instructions and complete seal after delivery within 18 months.

DTSU666 series and DSSU666 series three phase electronic energy meter(DIN-Rail)	ZTY0.464.1002
Operation manual	Page 13, Total 13

Dear clients,

Please assist us: when the product life is end, to protect our environment, please recycle the product or components, while for the materials that cannot be recycled, please also deal with it in a proper way. Really appreciate your cooperation and support.